

8 7 6 5 4 3 2 1

ARROWS INDICATE FABRIC DIRECTION ON ROLL

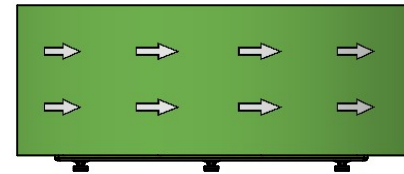
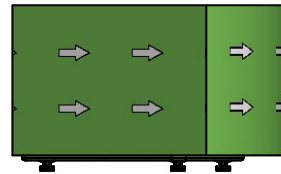
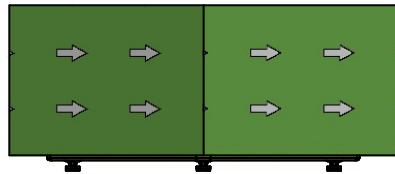
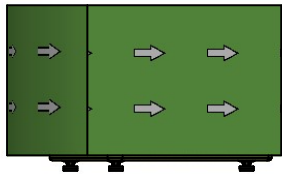
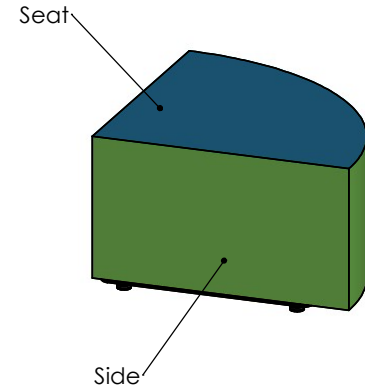
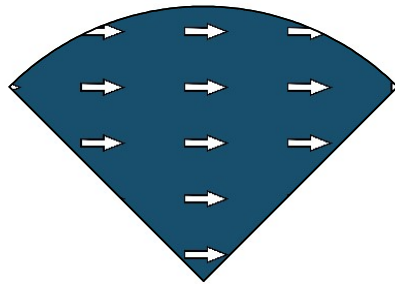
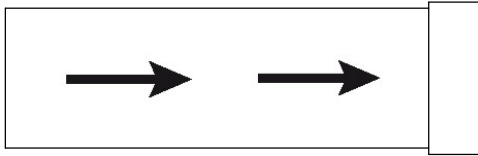

REVISIONS			
REV.	DESCRIPTION OF CHANGE	DATE	ENG
A	created	11/15/2023	BBM

Default thread color to match surface 1

Default zipper color to match zippered surface

Surface #	Surface Name	Color
1	Seat	
2	Side	

WEIGHT	NAME	DATE
lbs	B. Matiga	11/15/2023
CUST APPRVD.		

PROPRIETARY AND CONFIDENTIAL  
THE INFORMATION CONTAINED IN THIS DRAWING IS THE SOLE PROPERTY OF FOMCORE LLC. ANY REPRODUCTION IN PART OR AS A WHOLE WITHOUT THE WRITTEN PERMISSION OF FOMCORE LLC IS PROHIBITED.

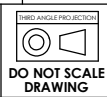

PART NO.	<b>FK021-Standard Colorguide</b>	SHEET 1 OF 1
DESCRIPTION	Train Station Wedge Standard Colorguide	REV A

8 7 6 5 4 3 2 1