

8 7 6 5 4 3 2 1

ARROWS INDICATE FABRIC DIRECTION ON ROLL

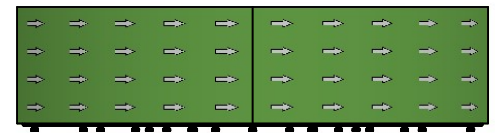
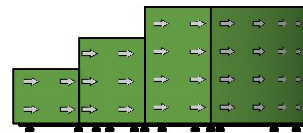
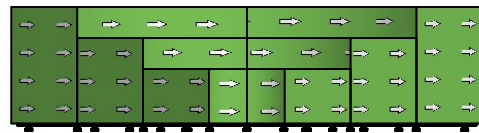
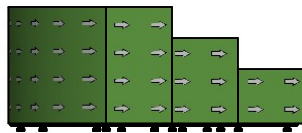
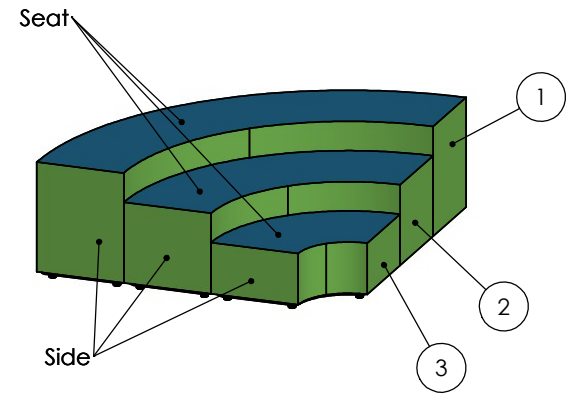
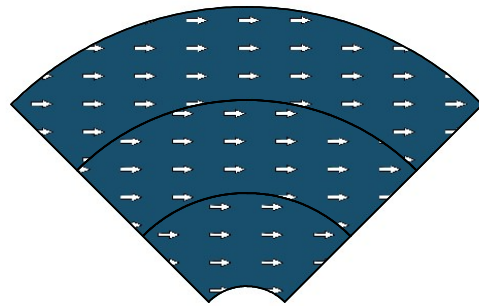
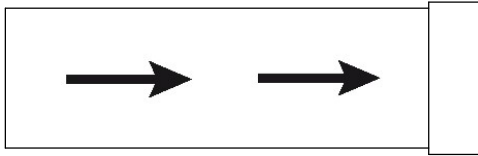

REVISIONS			
REV.	DESCRIPTION OF CHANGE	DATE	ENG
A	created	11/10/2023	BBM

ITEM #	PART NUMBER	DESCRIPTION	QTY
1	F570-91x18x24-G1	EXTERNAL ARC, 91L x 18W x 24H, GLIDES	1
2	F571-65.5x18x18-G1	MIDDLE ARC - 65.5L x 18W x 18H, GLIDES	1
3	F572-40x18x12-G1	INTERNAL ARC, 40L x 18W x 12H, GLIDES	1

WEIGHT	NAME	DATE
100.82 lbs	B. Matiga	11/10/2023

PROPRIETARY AND CONFIDENTIAL  
 THE INFORMATION CONTAINED IN THIS DRAWING IS THE SOLE PROPERTY OF FOMCORE LLC. ANY REPRODUCTION IN PART OR AS A WHOLE WITHOUT THE WRITTEN PERMISSION OF FOMCORE LLC IS PROHIBITED.

PART NO.	<b>F044-Standard Colorguide</b>	SHEET 1 OF 1
DESCRIPTION	Rainbow Tier Set Standard Colorguide	REV A

Default thread color to match surface 1

Default zipper color to match zippered surface

Surface #	Surface Name	Color
1	Seat	
2	Side	

8 7 6 5 4 3 2 1