

8 7 6 5 4 3 2 1

ARROWS INDICATE FABRIC DIRECTION ON ROLL

REVISIONS			
REV.	DESCRIPTION OF CHANGE	DATE	ENG
A	created	2/7/2023	BBM

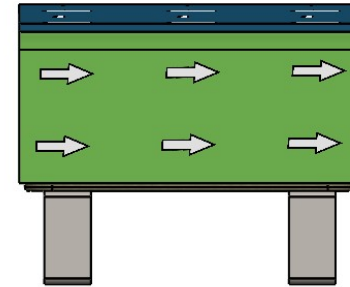
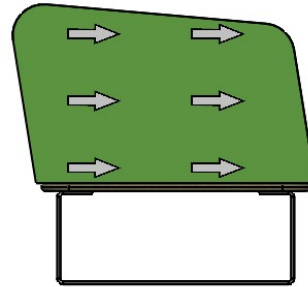
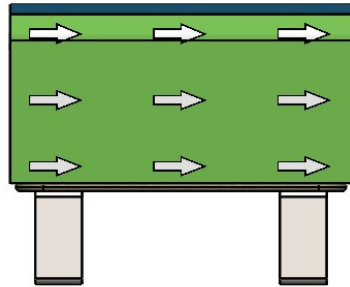
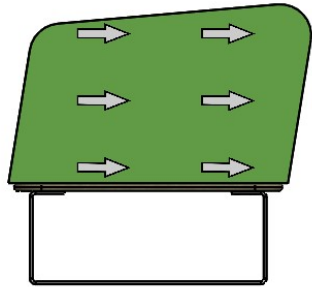
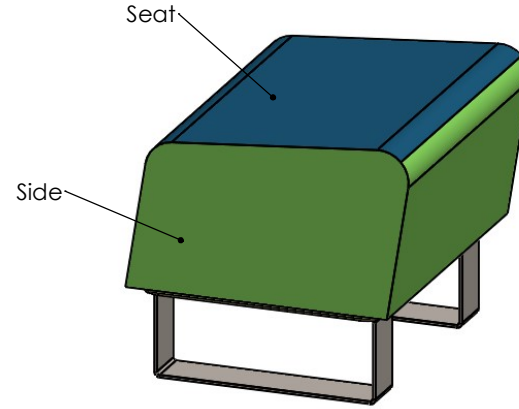
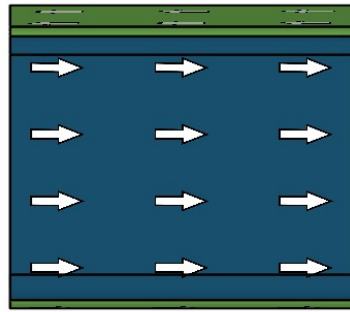
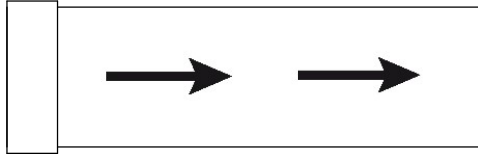

A

Default thread color to match surface 1

Default zipper color to match zippered surface

Surface #	Surface Name	Color
1	Seat	
2	Side	

WEIGHT	NAME	DATE
19.02 lbs	B. Matiga	5/24/2023

CUST APPRVD.

**PROPRIETARY AND CONFIDENTIAL**  
 THE INFORMATION CONTAINED IN THIS DRAWING IS THE SOLE PROPERTY OF FOMCORE LLC. ANY REPRODUCTION IN PART OR AS A WHOLE WITHOUT THE WRITTEN PERMISSION OF FOMCORE LLC IS PROHIBITED.



PART NO.	<b>F142-Standard Colorguide</b>	SHEET 1 OF 1
DESCRIPTION	Linear Refresh Ottoman Standard Colorguide	REV A

8 7 6 5 4 3 2 1