

8 7 6 5 4 3 2 1

ARROWS INDICATE FABRIC DIRECTION ON ROLL

REVISIONS			
REV.	DESCRIPTION OF CHANGE	DATE	ENG
A	created	2/8/2023	BBM

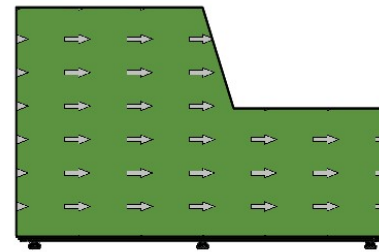
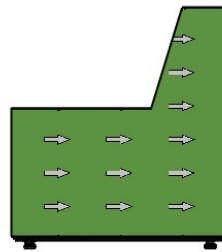
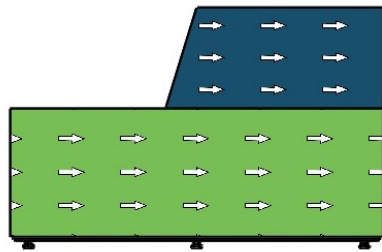
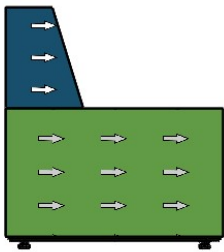
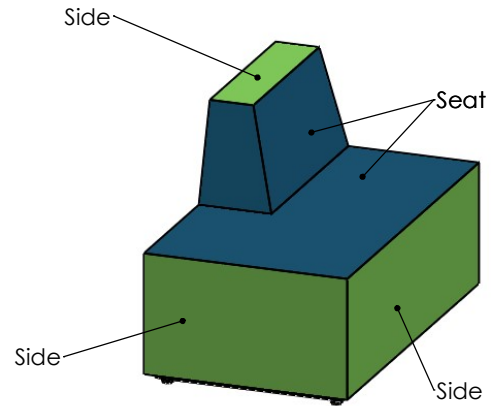
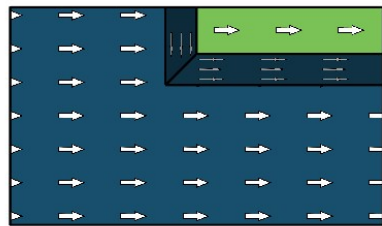
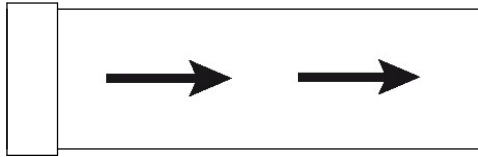

Default thread color to match surface 1

Default zipper color to match zippered surface

Surface	Color
Seat	
Side	

WEIGHT	NAME	DATE
42.91 lbs		5/23/2023

CUST APPRVD.

PROPRIETARY AND CONFIDENTIAL
THE INFORMATION CONTAINED IN THIS DRAWING IS THE SOLE PROPERTY OF FOMCORE LLC. ANY REPRODUCTION IN PART OR AS A WHOLE WITHOUT THE WRITTEN PERMISSION OF FOMCORE LLC IS PROHIBITED.



Fōmcore
SERVE. CREATE. INSPIRE.

PART NO. **F136-Standard Colorguide**
DESCRIPTION **Connect Low Back Sofa Standard Colorguide**

SHEET 1 OF 1
REV A

8 7 6 5 4 3 2