

ARROWS INDICATE FABRIC DIRECTION ON ROLL

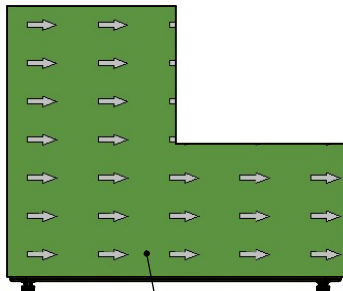

Back

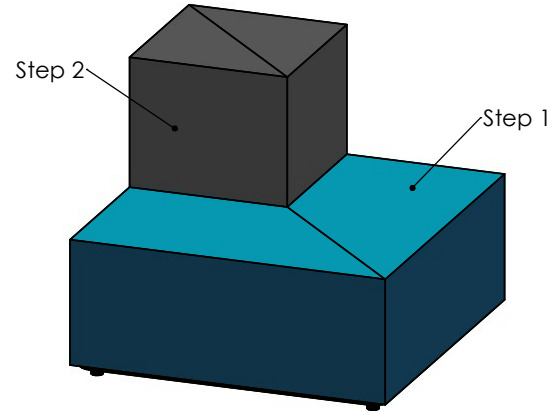
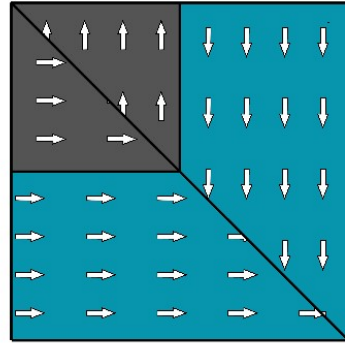
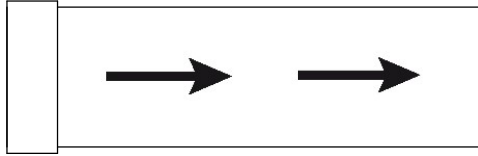
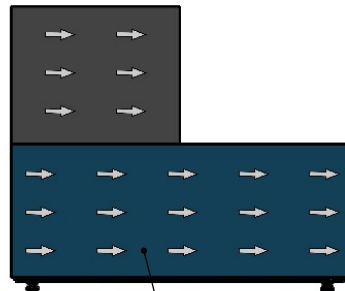

Side

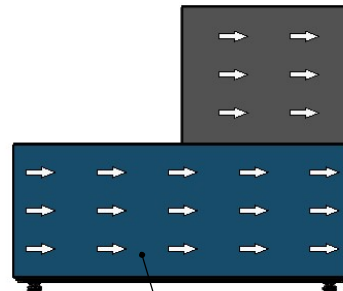

Side

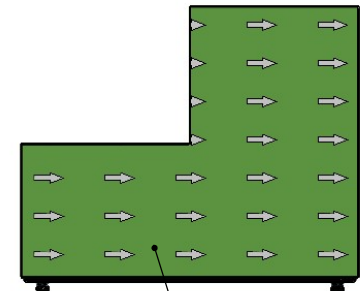

Back

REVISIONS			
REV.	DESCRIPTION OF CHANGE	DATE	ENG
A	created	6/21/2023	BBM

Default thread color to match surface 1

Default zipper color to match zippered surface

Surface #	Surface Name	Color
1	Side	
2	Back	
3	Step 1	
4	Step 2	

WEIGHT	NAME	DATE
46.43 lbs	B. Matiga	6/21/2023
CUST APPRVD.		

PROPRIETARY AND CONFIDENTIAL  
THE INFORMATION CONTAINED IN THIS DRAWING IS THE SOLE PROPERTY OF FOMCORE LLC. ANY REPRODUCTION IN PART OR AS A WHOLE WITHOUT THE WRITTEN PERMISSION OF FOMCORE LLC IS PROHIBITED.



PART NO. **F030-Standard Colorguide**

DESCRIPTION **Outside 2 Step Standard Colorguide**

SHEET 1 OF 1

REV A