

8 7 6 5 4 3 2 1

ARROWS INDICATE FABRIC DIRECTION ON ROLL

REVISIONS			
REV.	DESCRIPTION OF CHANGE	DATE	ENG
A	created	4/20/2023	BBM

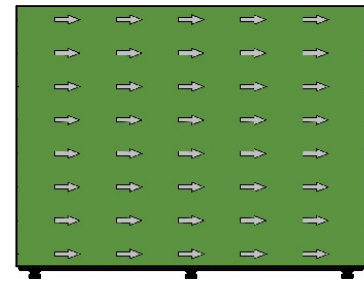
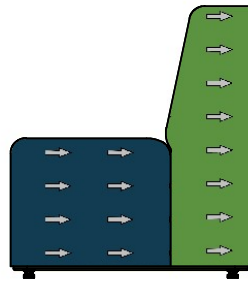
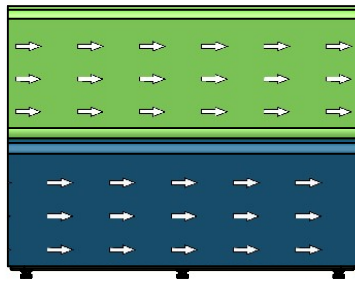
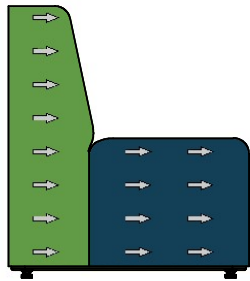
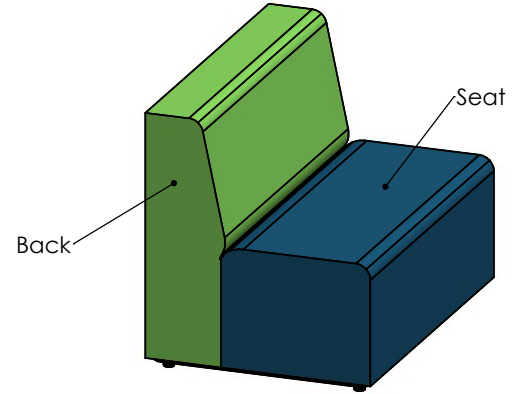
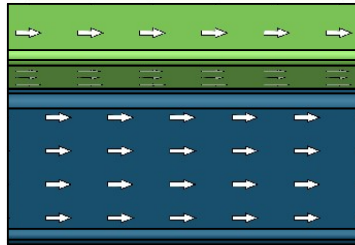
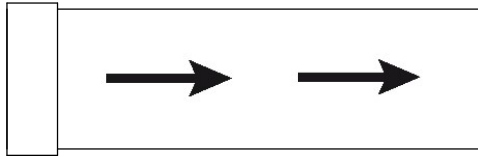

Default thread color to match surface 1 - Seat

Surface	Color
Seat	
Back	

WEIGHT	NAME	DATE
48.67 lbs	B. Matiga	5/19/2023

CUST APPRVD.

PROPRIETARY AND CONFIDENTIAL
THE INFORMATION CONTAINED IN THIS DRAWING IS THE SOLE PROPERTY OF FOMCORE LLC. ANY REPRODUCTION IN PART OR AS A WHOLE WITHOUT THE WRITTEN PERMISSION OF FOMCORE LLC IS PROHIBITED.

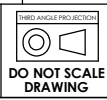

		PART NO.	F017-Standard Colorguide	SHEET 1 OF 1
		DESCRIPTION		

8 7 6 5 4 3 2