

Art-F003

TOP VIEW

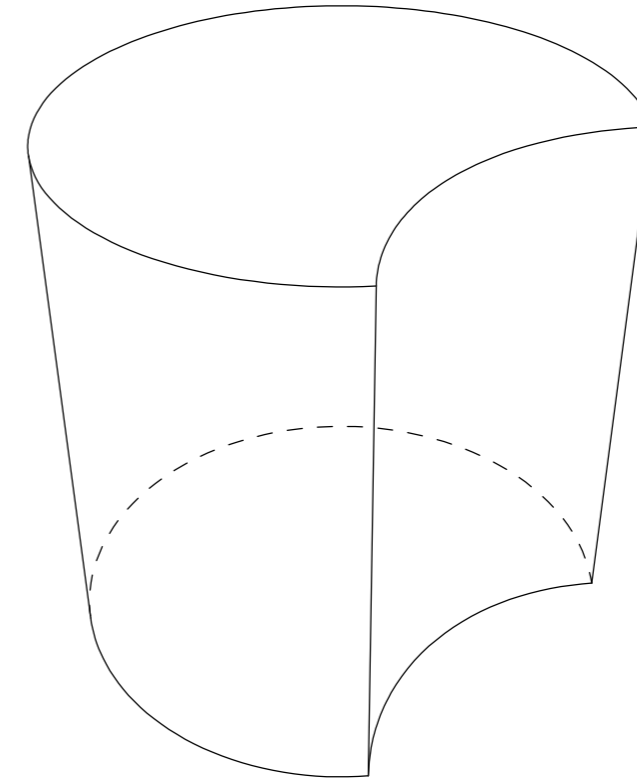

FRONT VIEW

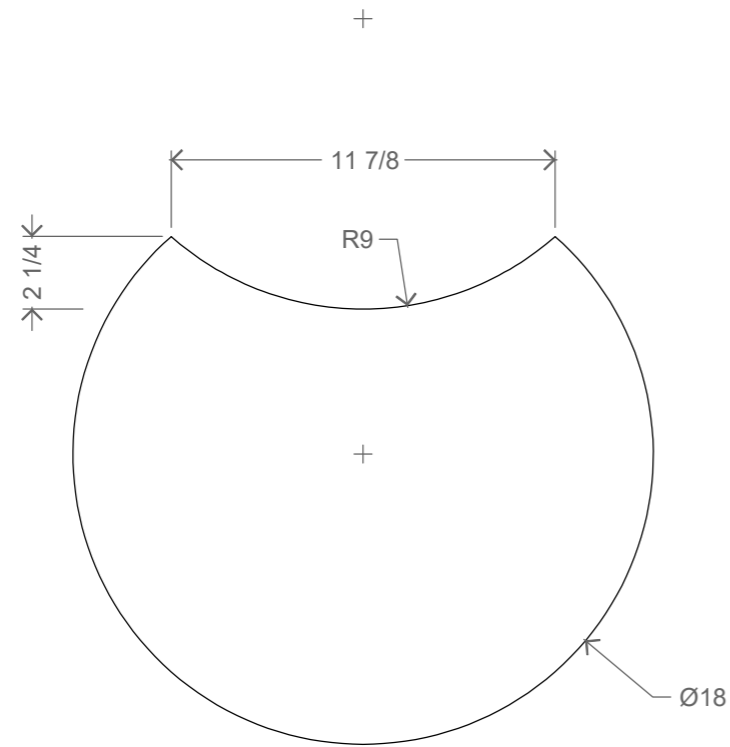
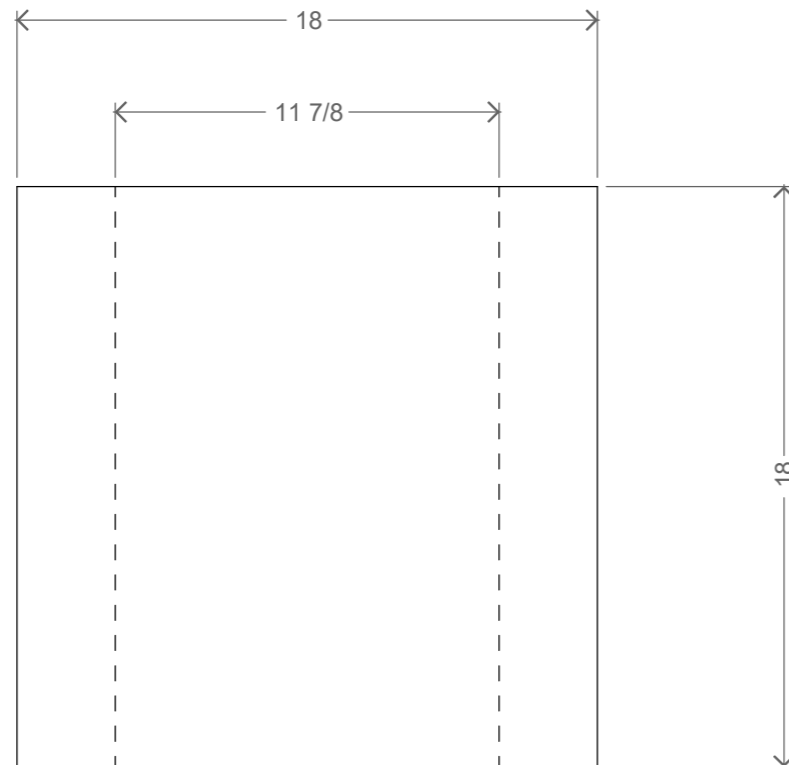

SIDE VIEW



Project	Part	Subject	Material	Unit	Date
FoamFurniture	F003	TOP	PU Foam	inches	20181003
Design	Draw	Client			
@Ind. D. Michel Lugo Tamayo			Z Supply		