

ARMLESS SERIES

CURVED SOFA IN

Product No. F020

The shortest distance between 2 points may be a straight line, but the curved pieces in our Armless Series can be a whole lot more fun and useful for creating attractive spaces. Cultivate creativity and engage the senses with endless possibilities of combinations utilizing all our Armless pieces. Combine multiple pieces to form serpentine, as little or as much of a circle as desired, or any other design. The Curved Sofa In turns a corner at 60 degrees and is the same overall width as our Armless Sofa.

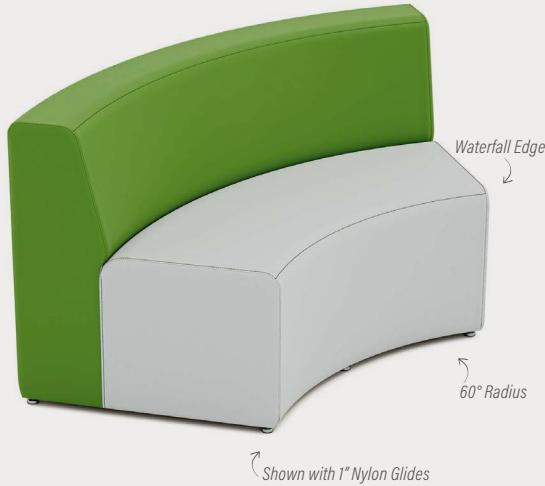

DETAILS

CONSTRUCTION

- Solid foam construction
- Reinforced seams and stitching
- Wood base to fit foot options
- Waterfall edge
- Made in USA
- Backed with a lifetime warranty

MODIFICATION

- Seat height
- Textile and placement
- Foot and finish options
- Stitching color
- Embroidery

QUICK COMBOS

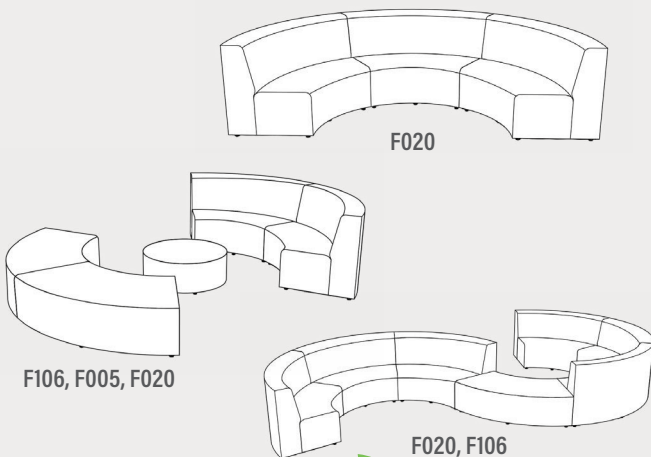

HOW TO SPECIFY F020

STEP 1: SEAT HEIGHT

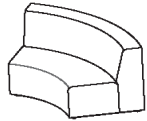
	DIMENSION (L x W x H)	SEAT HEIGHT
	40" x 20" x 23"	12"
	50" x 23.5" x 27"	14"
	67" x 31" x 33"	16"
	67" x 31" x 35"	18"

STEP 2: FOOT









1" STANDARD FOOT OPTIONS

-  Nylon Glide (G1)
-  Felt Glide (G1)
-  1" Low Profile Leg (L1) Black

3" PREMIUM FOOT OPTIONS

-  3" Rectangle (R3) Black
-  3" Rectangle (R3) Silver
-  3" Caster (C3)

6" PREMIUM FOOT OPTIONS

-  Large Sled Leg (S29) Silver
-  Large Sled Leg (S29) Black
-  6" Mod Leg (M6)
-  6" Rectangle (R6) Black
-  6" Rectangle (R6) Silver
-  6" Triangle (T6) Black
-  6" Triangle (T6) Silver
-  6" Caster (C6)

*Reference the product breakdown on back for availability.

STEP 3: GRADE AND TEXTILE

GRADES & SWATCHES



[CLICK TO VIEW »](#)

FABRIC DIRECTION & COLOR GUIDE



[CLICK TO VIEW »](#)

COLOR GUIDE

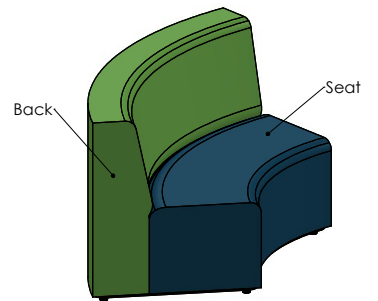

*Thread will default to match the seat textile.

STEP 4: MODIFICATIONS (OPTIONAL)

EMBROIDERY

- Personalize your furniture with embroidery!
- We can embroider up to 12" x 15" artwork

EMBROIDERY SPECS

[CLICK TO VIEW »](#)



FLAME RETARDANT

- CAL TB-133
- Optional flame retardant add on.

*Reference the product breakdown on back for availability.

STEP 5: CONFIGURE PART NUMBER

FILL IN YOUR PART NUMBER

F	0	2	0	-		x		x		-			
FAMILY					L	W	H	FOOT					
STEP 1								STEP 2					

EXAMPLE PART NUMBER

F	0	2	0	-	5	0	x	2	3	5	x	2	7	-	R	6
FAMILY					L	W	H	FOOT								

STEP 6: CONFIGURE DESCRIPTION

FILL IN YOUR DESCRIPTION

1. SEAT

1. Seat				
LOCATION	GRADE	MANUFACTURER	PATTERN	COLOR

2. BACK

2. Back				
LOCATION	GRADE	MANUFACTURER	PATTERN	COLOR

FOOT

NAME/COLOR

EMBROIDERY*

LOCATION	NAME

FLAME RETARDANT*

--

STEP 3

EXAMPLE DESCRIPTION

1. SEAT

1. Seat	1	Spradling	Silvertex	Sage
LOCATION	GRADE	MANUFACTURER	PATTERN	COLOR

2. BACK

2. Back	3	Momentum	Tribeca	Fossil
LOCATION	GRADE	MANUFACTURER	PATTERN	COLOR

FOOT

6" Rectangle Leg - Black

NAME/COLOR

EMBROIDERY*

Seat	Rocket Logo
LOCATION	NAME

FLAME RETARDANT*

CAL TB-133

*Optional add-ons. Reference product breakdown for availability.

INCLUDE ON PURCHASE ORDER

EXAMPLE CONFIGURATION

F020-50x23.5x27-R6

1. Seat: Grade 1, Spradling, Silvertex, Sage | 2. Back: Grade 3, Momentum, Tribeca, Fossil

Foot: 6" Rectangle Leg Black | Embroidery: Seat, Rocket logo | CAL TB 133

PRODUCT BREAKDOWN

CURVED SOFA IN (F020)

60° Angle

Product No.	Dimen./Weight (L x W x H)	Zip Z	FOOT AND FINISH OPTIONS											INTEGRATED POWER OPTIONS										HPL	Emb.
			Standard			3" Premium		6" Premium						Standard		3" Premium		6" Premium							
			G1	L1	R3	C3	S16	S29	C6	T6	R6	M6	G1	L1	R3	C3	S16	S29	C6	T6	R6	M6			
F020-40x20x23	40" x 20" x 23" 16.5 lbs. (12" Seat Height)	-	✓	✓	✓	✓	-	-	-	-	-	-	-	-	-	-	-	-	-	-	-	-	-	-	✓
F020-50x23.5x27	50" x 23.5" x 27" 27 lbs. (14" Seat Height)	-	✓	✓	✓	✓	-	-	-	-	-	-	-	-	-	-	-	-	-	-	-	-	-	-	✓
F020-67x31x33	67" x 31" x 33" 60 lbs. (16" Seat Height)	-	✓	✓	✓	✓	-	✓	✓	✓	✓	✓	-	-	-	-	-	-	-	-	-	-	-	-	✓
F020-67x31x35	67" x 31" x 35" 67 lbs. (18" Seat Height)	-	✓	✓	✓	✓	-	✓	✓	✓	✓	✓	-	-	-	-	-	-	-	-	-	-	-	-	✓



1770 E. Keating Ave - Muskegon, MI 49442 • Tel: 231.366.4791 • www.fomcore.com

ADDITIONAL RESOURCES



[CLICK TO VIEW >](#)