

8 7 6 5 4 3 2 1

ARROWS INDICATE FABRIC DIRECTION ON ROLL

REVISIONS			
REV.	DESCRIPTION OF CHANGE	DATE	ENG
A	created	9/21/2023	BBM

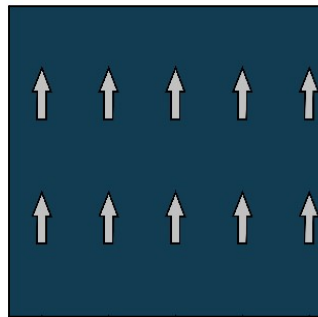
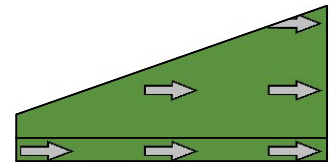
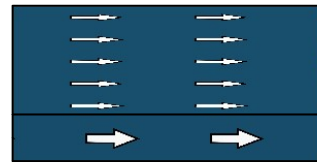
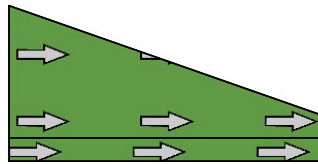
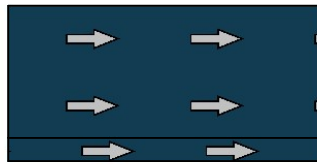
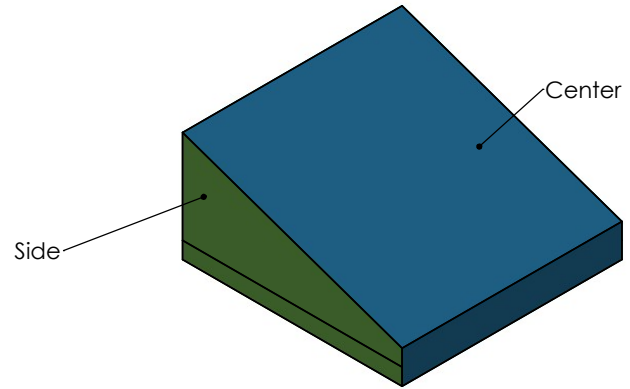
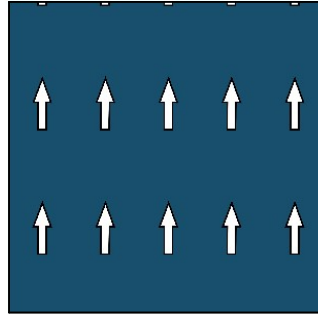

Default thread color to match surface 1

Default zipper color to match zippered surface

Surface #	Surface Name	Color
1	Center	
2	Side	

WEIGHT	NAME	DATE
lbs	B. Matiga	9/21/2023

CUST APPRVD.

PROPRIETARY AND CONFIDENTIAL
 THE INFORMATION CONTAINED IN THIS DRAWING IS THE SOLE PROPERTY OF FOMCORE LLC. ANY REPRODUCTION IN PART OR AS A WHOLE WITHOUT THE WRITTEN PERMISSION OF FOMCORE LLC IS PROHIBITED.



PART NO. FK064-Custom Colorguide	SHEET 1 OF 1
DESCRIPTION Fun Straight Ramp Custom Colorguide	REV A

8 7 6 5 4 3 2 1