

8 7 6 5 4 3 2 1

ARROWS INDICATE FABRIC DIRECTION ON ROLL

REVISIONS			
REV.	DESCRIPTION OF CHANGE	DATE	ENG
A	created	9/20/2023	BBM

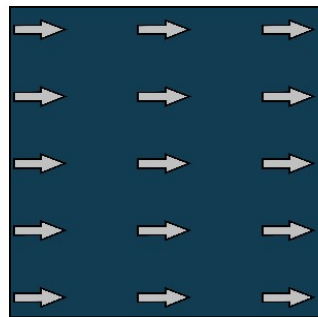
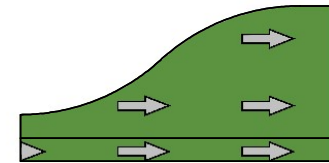
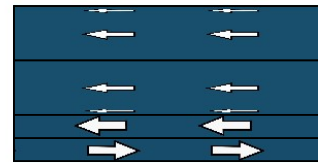
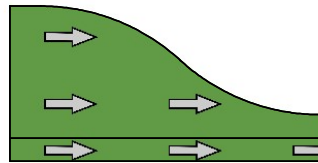
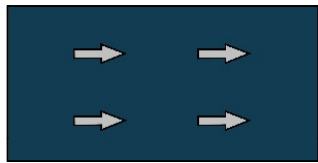
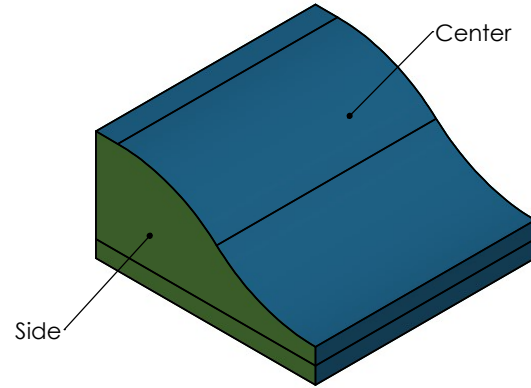
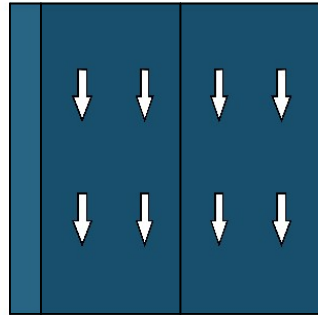
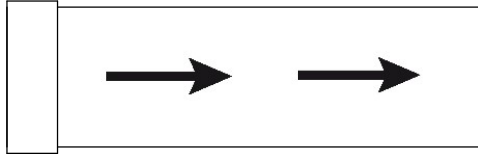

*When using a patterned textile we are unable to match pattern across seams.

Default thread color to match surface 1

Default zipper color to match zippered surface

Surface #	Surface Name	Color
1	Center	
2	Side	

WEIGHT	NAME	DATE
lbs	B. Matiga	9/21/2023

CUST APPRVD.

PROPRIETARY AND CONFIDENTIAL
THE INFORMATION CONTAINED IN THIS DRAWING IS THE SOLE PROPERTY OF FOMCORE LLC. ANY REPRODUCTION IN PART OR AS A WHOLE WITHOUT THE WRITTEN PERMISSION OF FOMCORE LLC IS PROHIBITED.



		SHEET 1 OF 1
PART NO.	FK063-Custom Colorguide	REV A
DESCRIPTION	Fun Curved Ramp Custom Colorguide	

8 7 6 5 4 3 2 1