

8 7 6 5 4 3 2 1

ARROWS INDICATE FABRIC DIRECTION ON ROLL

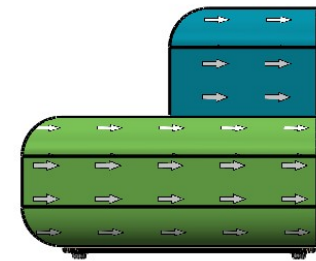
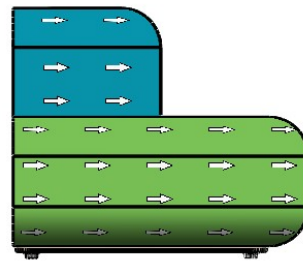
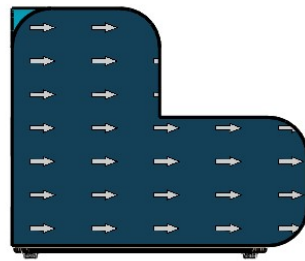
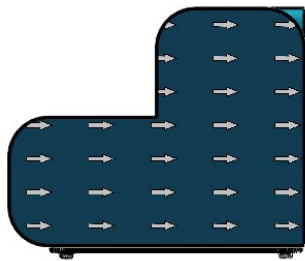
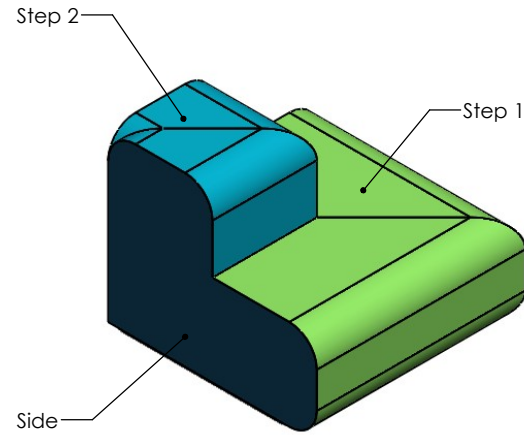
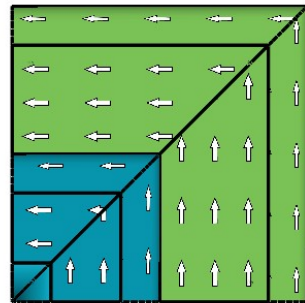
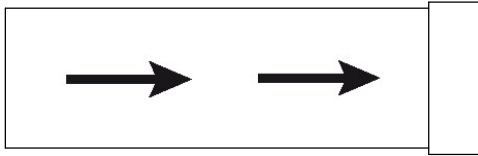

REVISIONS			
REV.	DESCRIPTION OF CHANGE	DATE	ENG
A	created	7/29/2024	BBM

Default thread color to match surface 1

Default zipper color to match zippered surface

Surface #	Surface Name	Color
1	Side	
2	Step 1	
3	Step 2	

WEIGHT	NAME	DATE
lbs	B. Matiga	7/29/2024

PROPRIETARY AND CONFIDENTIAL
 THE INFORMATION CONTAINED IN THIS DRAWING IS THE SOLE PROPERTY OF FOMCORE LLC. ANY REPRODUCTION IN PART OR AS A WHOLE WITHOUT THE WRITTEN PERMISSION OF FOMCORE LLC IS PROHIBITED.



Fōmcore
 SERVE. CREATE. INSPIRE.

Drawing NO.	F155-Standard Colorguide	SHEET 1 OF 1
DESCRIPTION	Bubble 2-Step OUT Standard Colorguide	REV A

8 7 6 5 4 3 2