

8 7 6 5 4 3 2 1

ARROWS INDICATE FABRIC DIRECTION ON ROLL

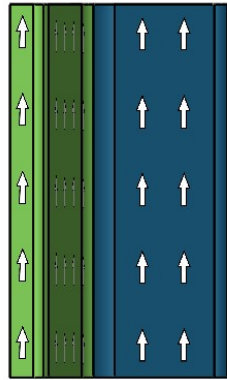

2. Back

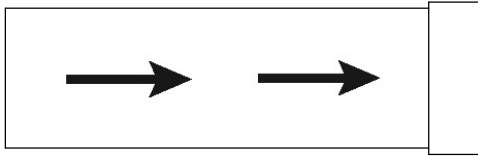
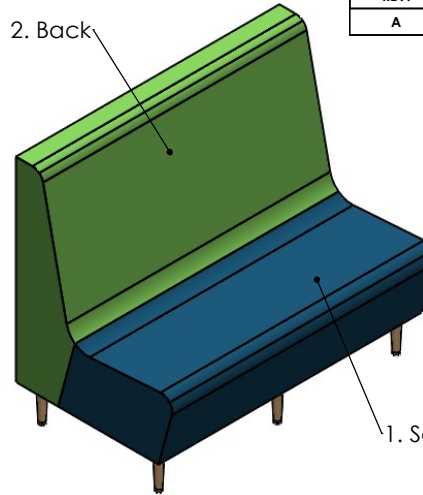

1. Seat

REVISIONS			
REV.	DESCRIPTION OF CHANGE	DATE	ENG
A	created	1/17/2022	BBM

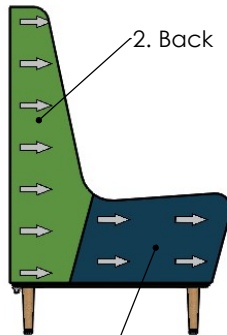
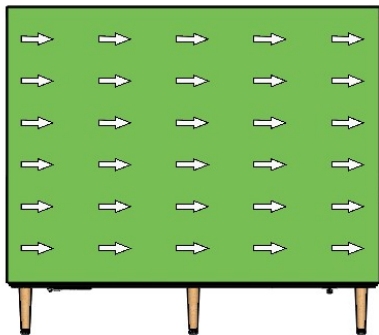

1. Seat

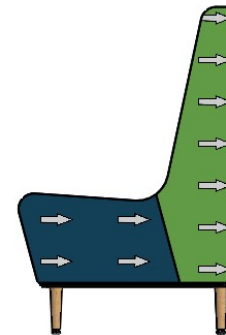
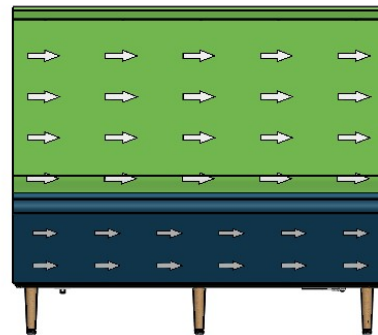

Default thread color to match surface 1

Default zipper color to match zippered surface

Surface #	Surface Name	Color
1	Seat	
2	Back	

WEIGHT	NAME	DATE
51.74 lbs	B. Matiga	10/17/2023

CUST APPRVD.  
 PROPRIETARY AND CONFIDENTIAL  
 THE INFORMATION CONTAINED IN THIS DRAWING IS THE SOLE PROPERTY OF FOMCORE LLC. ANY REPRODUCTION IN PART OR AS A WHOLE WITHOUT THE WRITTEN PERMISSION OF FOMCORE LLC IS PROHIBITED.



PART NO.	<b>F131-Standard Colorguide</b>	SHEET 1 OF 1
DESCRIPTION	Cafe Booth Standard Colorguide	REV A

8 7 6 5 4 3 2 1