

8 7 6 5 4 3 2 1

ARROWS INDICATE FABRIC DIRECTION ON ROLL

REVISIONS			
REV.	DESCRIPTION OF CHANGE	DATE	ENG
A	created	6/21/2023	BBM

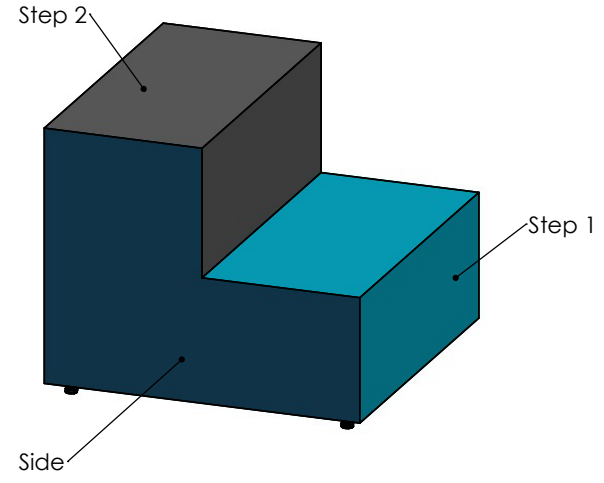
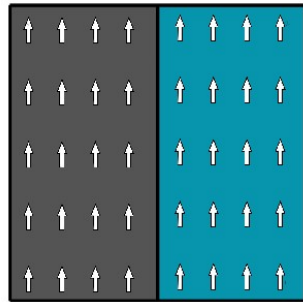
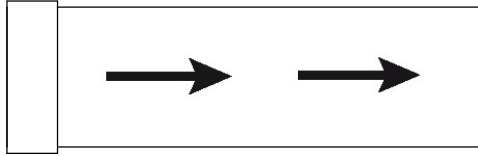

Back

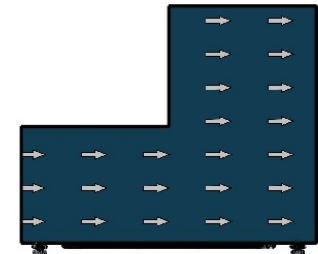
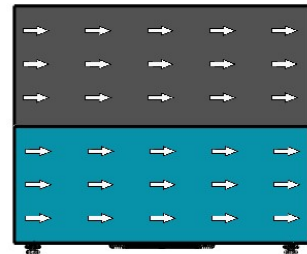
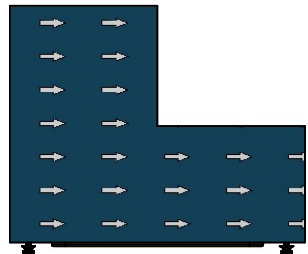
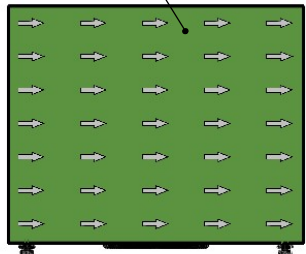

Default thread color to match surface 1

Default zipper color to match zippered surface

Surface #	Surface Name	Color
1	Side	
2	Back	
3	Step 1	
4	Step 2	

WEIGHT	NAME	DATE
37.27 lbs	B. Matiga	6/21/2023

CUST APPRVD.

PROPRIETARY AND CONFIDENTIAL
THE INFORMATION CONTAINED IN THIS DRAWING IS THE SOLE PROPERTY OF FOMCORE LLC. ANY REPRODUCTION IN PART OR AS A WHOLE WITHOUT THE WRITTEN PERMISSION OF FOMCORE LLC IS PROHIBITED.

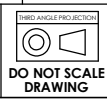

PART NO.	F027-Standard Colorguide	SHEET 1 OF 1
DESCRIPTION	2 Step Standard Colorguide	REV A

8 7 6 5 4 3 2 1